

Product Datasheet

Swing PZA R512

Aluminum round profile $\varnothing 89$

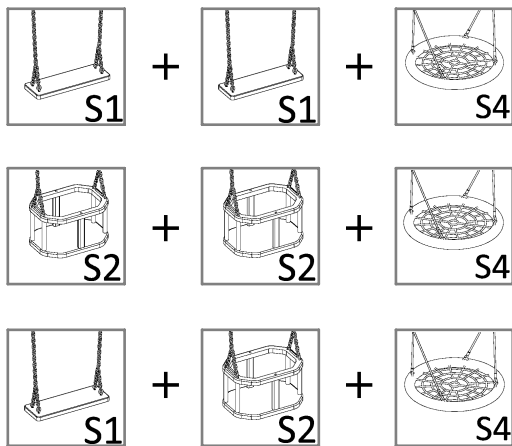

Age:

- 3+
- 0-3 years (baby box seat)

Amount of users: 8

Safety zone:

- for loose surface: 535 x 750 cm (40,2 m²)
- for rubber safety flooring: 535 x 650 cm (34,8 m²)

Free fall height: 125 cm

Weight of the playset: 130 kg

Dimension of the biggest part: 315x8,9x8,9 cm

Product compliant with PN-EN 1176-1, PN-EN 1176-2+AC: YES

Spare parts availability: YES

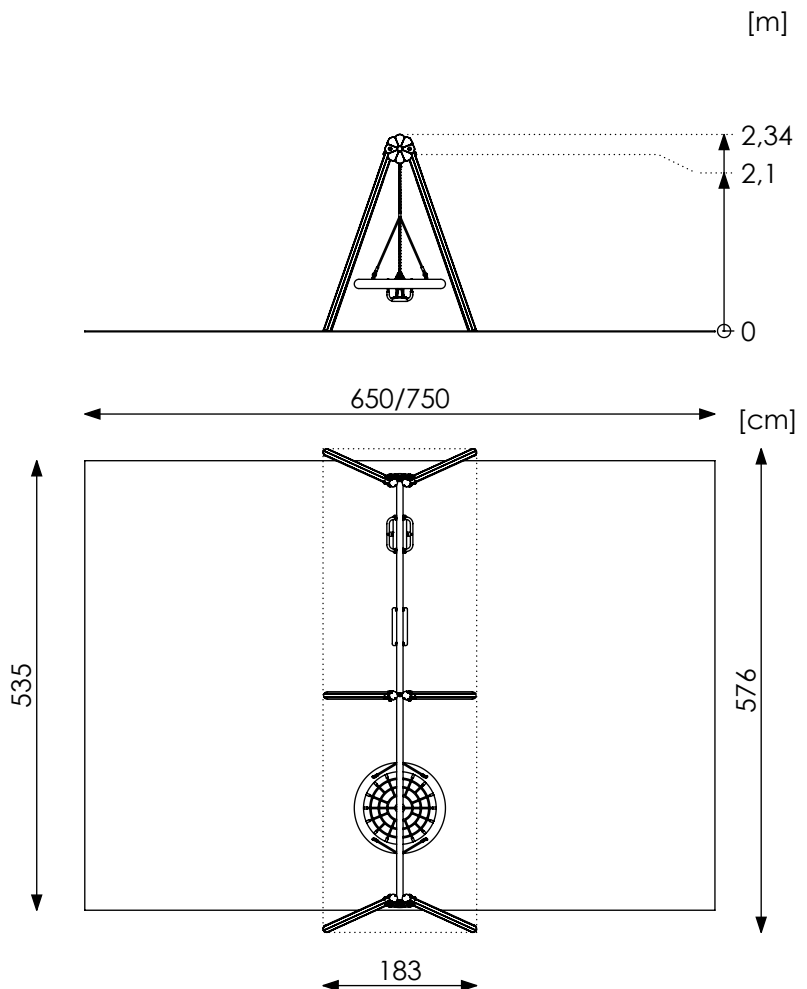

Mounting:

The set is mounted in the ground.
Foundations made of C20/25 concrete.

Material specification:

- Construction poles made from aluminum round profiles \varnothing 89 mm with anodized finish.
- Steel pipe beam \varnothing 76,1x3,2 mm, hot dip galvanized.
- Slings with bearings, maintenance-free, hot dip galvanized or stainless steel with swivels.
- Top of the poles secured by cap made from HDPE.
- Screws, bolts etc. covered by colorful plugs from plastic.
- Stainless steel chains \varnothing 6 mm.
- Rubber seats with aluminum insert.
- "Birdnest" seat with reinforced ropes in a polypropylene braid \varnothing 16 mm.

Renders are for reference only, actual appearance may differ from the one shown on the render.

Acceptable shock absorbing surfaces and their minimum thickness

Material ^a	Description [mm]	Minimum depth ^b [cm]	Maximum free heights of fall [cm]
Turf/topsoil		-	≤ 100 ^d
Bark	20 to 80 particle size	20	≤ 200
		30	≤ 300
Woodchip	5 to 30 particle size	20	≤ 200
		30	≤ 300
Sand or gravel ^c	0,25 to 8 grain size	20	≤ 200
		30	≤ 300
Other materials	As tested according to EN 1177		Critical fall height as tested

^a For further information on specific material properly prepared for use in children's playgrounds

^b For loose particulate material, add 100 mm to the minimum depth to compensate for displacement (see 4.2.8.5.1).

^c Sand and gravel shall be well rounded and washed to eliminate most of the silt or clay particles. Washed sand and gravel is considered to be from alluvial (natural eroded) deposits and free from most silt or clay particles. For gravel this may commonly be described as 'pea shingle'. Uniformity coefficient $D_{60}/D_{10} < 3,0$. Grain size can be identified by use of a sieve test, as in EN 933-1 (see Annex G)

^d See NOTE 2 in 4.2.8.5.2